

PRODUCT NO.	INSULATOR
10030581-100LF	NO
10030581-110LF	YES
10030581-200LF	NO
10030581-210LF	YES 10030591-100
10030581-220LF	YES 10030591-110
10030581-300LF	NO
10030581-310LF	YES

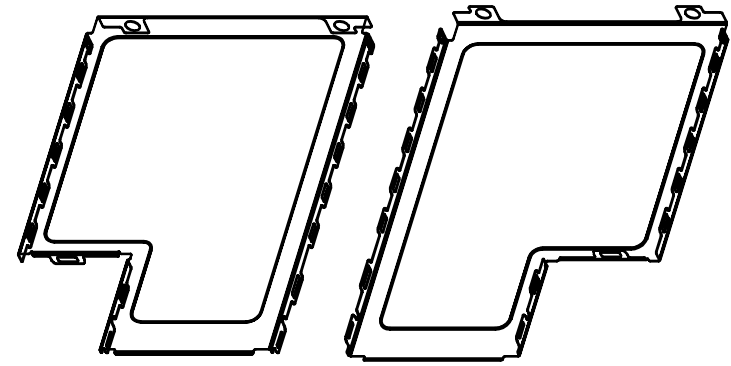
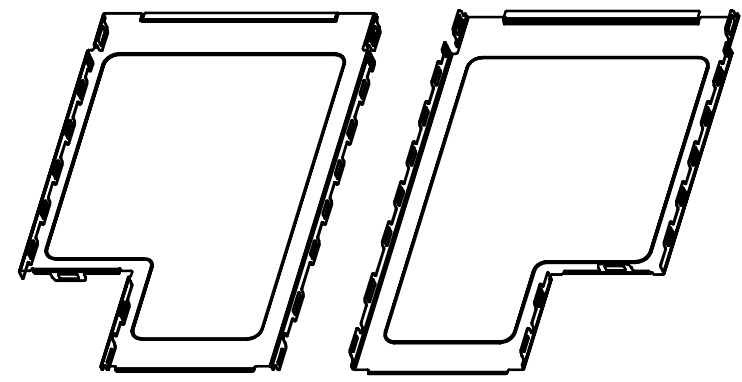
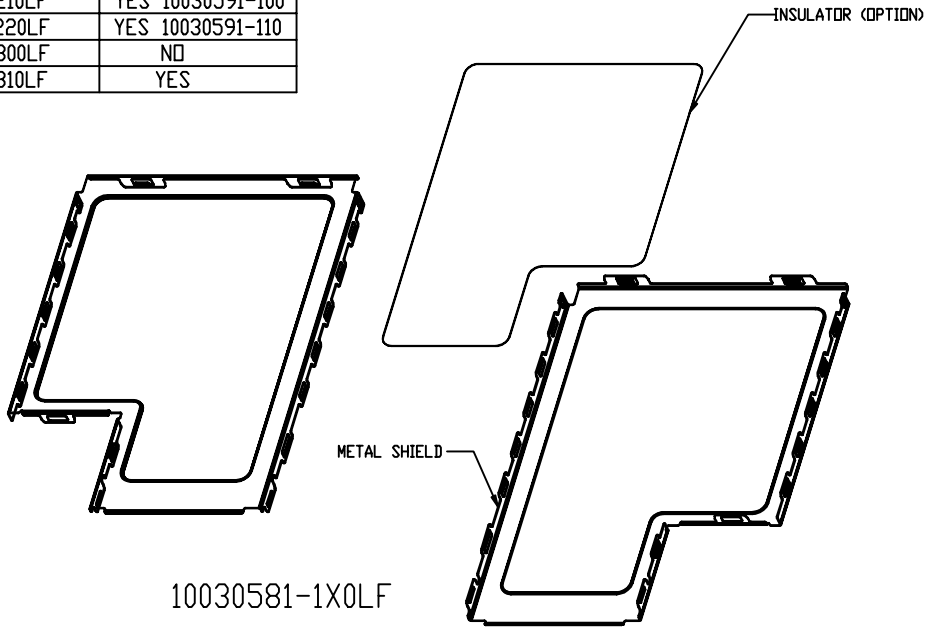

NOTES:  
 1. MATERIAL PROPERTIES:  
 METAL SHIELD : STAINLESS STEEL, SURFACE FINISH : MATTE.  
 INSULATOR : POLYESTER FILM WITH ADHESIVE, 3M 1350 OR EQUIVALENT.

2. PART NUMBER SCHEME:  
 10030581- X.X.X.L.F  
 X : RESERVED  
 INSULATOR  
 0 : NO  
 1 : STANDARD

SHIELD TYPE NO.  
 1 : STANDARD (CLOSE-END)  
 2 : EXTENDED (OPEN-END)  
 3 : CUSTOMIZED

3. PRODUCT PERFORMANCE PER SPEC. GS-12-292.  
 4. PACKAGING SPEC. PER GS-14-927.  
 5. THIS PRODUCT IS ROHS COMPLIANT, AND MEETS EUROPEAN UNION DIRECTIVES AND OTHER COUNTRY REGULATIONS AS PER GS-22-008.

rev	ecn no	dr	date
H	N07-0182	MSH	2007-08-08
D	T05-0228	D T	2005-10-18
E	T06-0015	D T	2006-01-16
F	T06-0057	D T	2006-04-17
G	T06-0144	D T	2006-08-02

www.fciconnect.com			surface	tolerance std	projection	MM
			ANGULAR	LINEAR	size	Scale
Dr	DAVID TENG	2004-10-04	0.X	±0.30	A4	1.000
Eng	DAVID TENG	2004-10-04	0.XX	±0.15	ECN	*
Chr	PAUL WANG	2004-10-04	0.XXX	±0.08	Spec ref	*
Appr	JOSEPH HSIA	2004-10-04	Product family			
FCI			title		cat no	Rev.
			TOP SHIELD SUB-ASSEMBLY		10030581	H
			EXPRESSCARD/54 MODULE CARD KIT		CUSTOMER	sheet 1 of 5
			catalog no		10030581	

REV F - 2006-04-17

PRODUCT NO.  
10030581-1X0LF

A

B

C

D

A

B

C

D

1

2

3

4

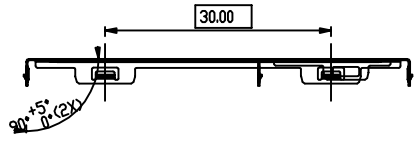
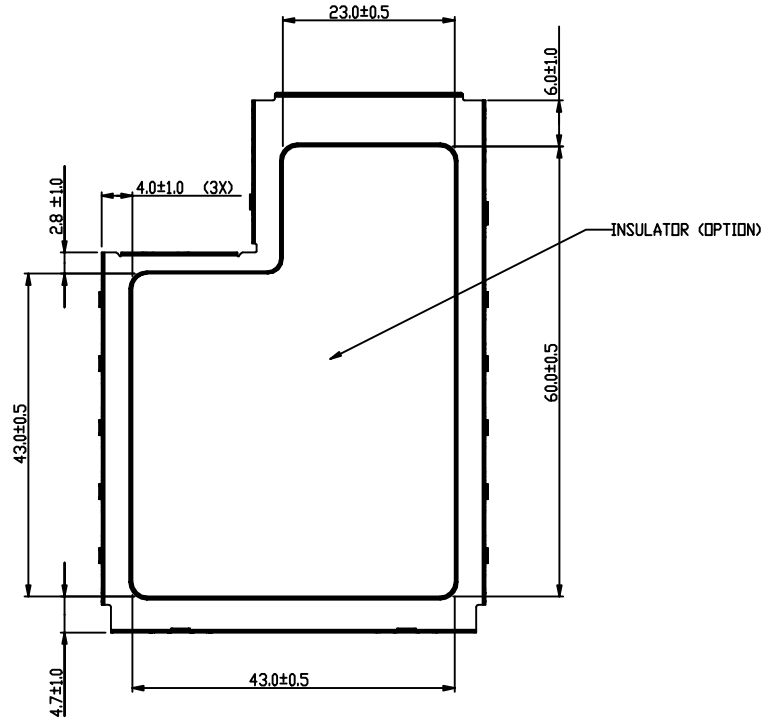
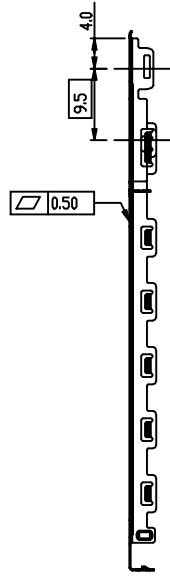
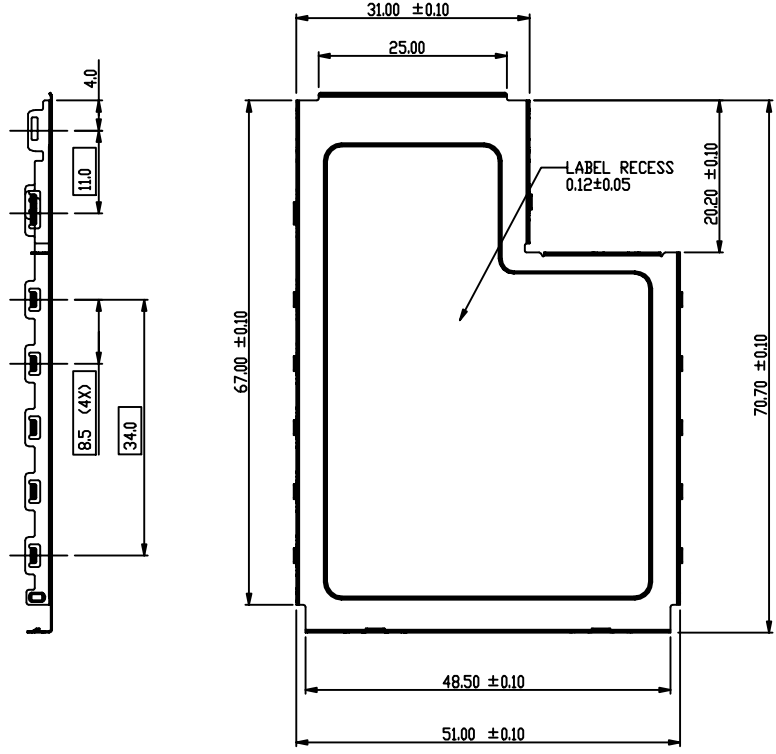

Copyright FCI.

TOLERANCES UNLESS OTHERWISE SPECIFIED		
LINEAR	0.X	±0.30
	0.XX	±0.15
	0.XXX	±0.08
ANGULAR	0°	±5°



title	TOP SHIELD SUB-ASSEMBLY		dwg no	10030581	Rev.	H
	EXPRESSCARD/54 MODULE CARD KIT					
catalog no	10030581	CUSTOMER	sheet 2 of 5			

REV F - 2006-04-17

1

2

3 PDM: Rev:H

STATUS Released

4

Printed: Oct 12, 2010

1

2

3

4

PRODUCT NO.  
10030581-2X0LF

A

B

C

D

A

B

C

D



Copyright FCI.

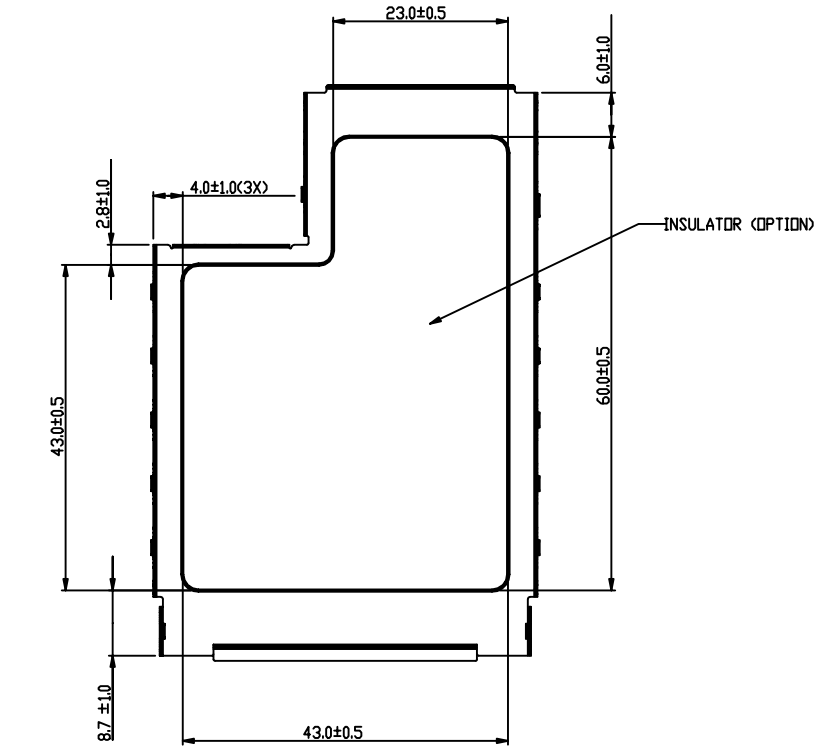
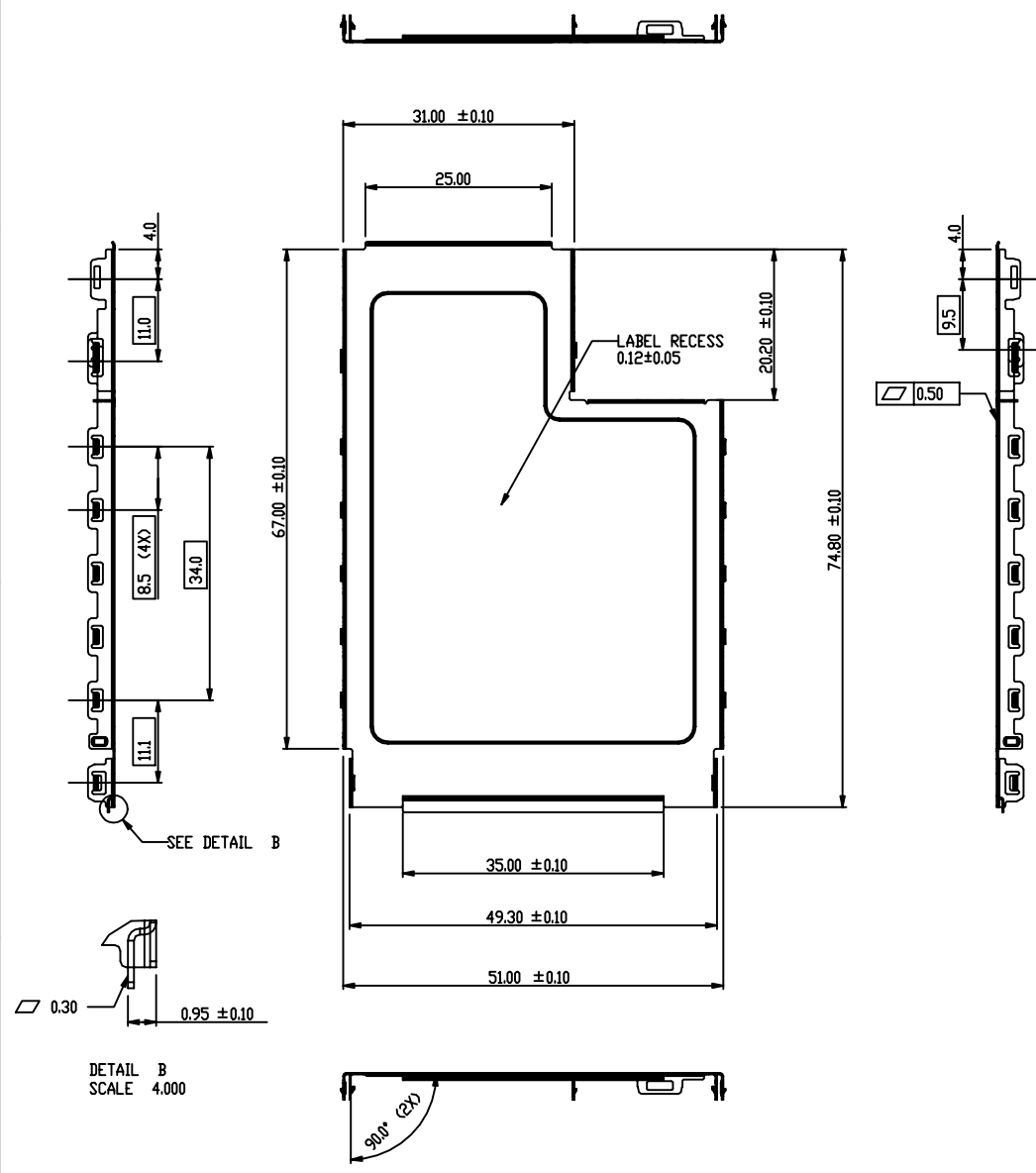

DETAIL B  
SCALE 4.000

TOLERANCES UNLESS OTHERWISE SPECIFIED		
LINEAR	0.X	±0.30
	0.XX	±0.15
	0.XXX	±0.08
ANGULAR	0°	±5°

	title TOP SHIELD SUB-ASSEMBLY EXPRESSCARD/54 MODULE CARD KIT	dwg no 10030581	Rev. H
	catalog no 10030581	CUSTOMER	sheet 3 of 5

REV F - 2006-04-17

1

2

3 PDM: Rev:H

STATUS Released

4

Printed: Oct 12, 2010

1

2

3

4

PRODUCT NO.  
10030581-220LF

A

B

C

D

A

B

C

D

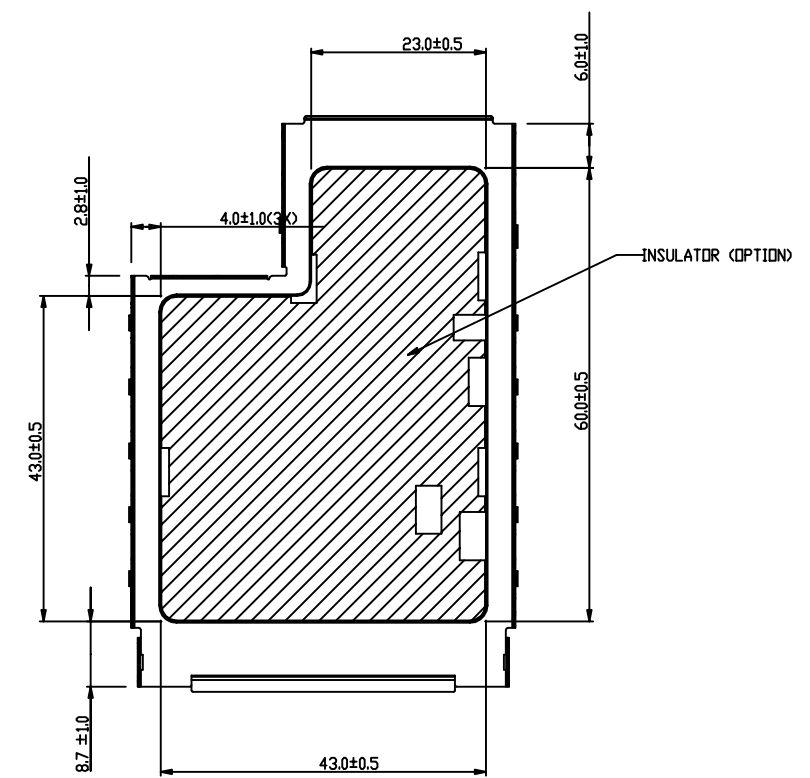
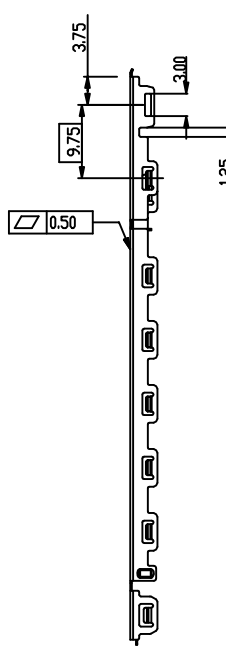
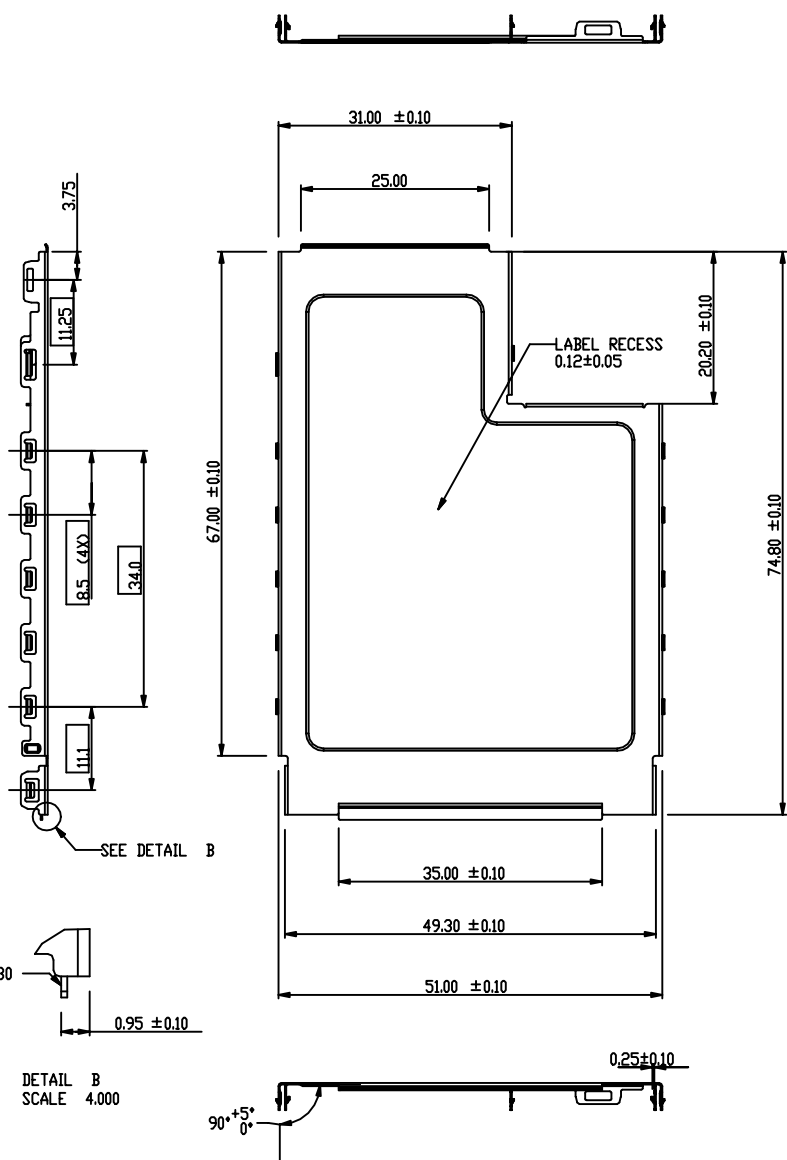

Copyright FCI.

DETAIL B  
SCALE 4.000

REV F - 0806-04-17

TOLERANCES UNLESS OTHERWISE SPECIFIED		
LINEAR	0.X	±0.30
	0.XX	±0.15
	0.XXX	±0.08
ANGULAR	0°	±5°

	title TOP SHIELD SUB-ASSEMBLY EXPRESSCARD/54 MODULE CARD KIT	dwg no 10030581	Rev. H
	catalog no 10030581	CUSTOMER	sheet 4 of 5

1

2

3 PDM: Rev:H

STATUS Released

4

Printed: Oct 12, 2010

PRODUCT NO.  
10030581-3X0LF

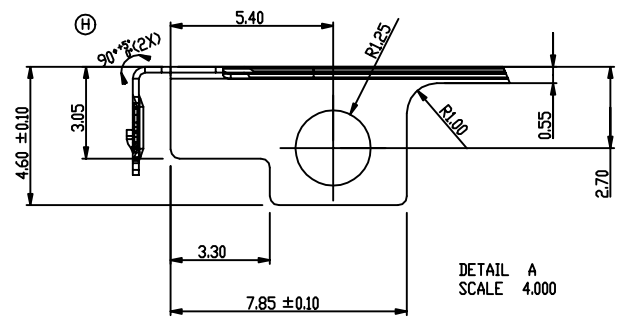
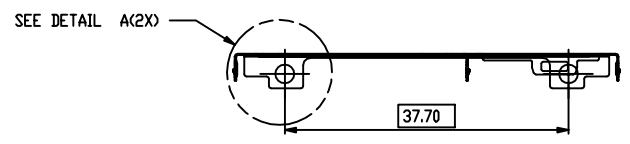
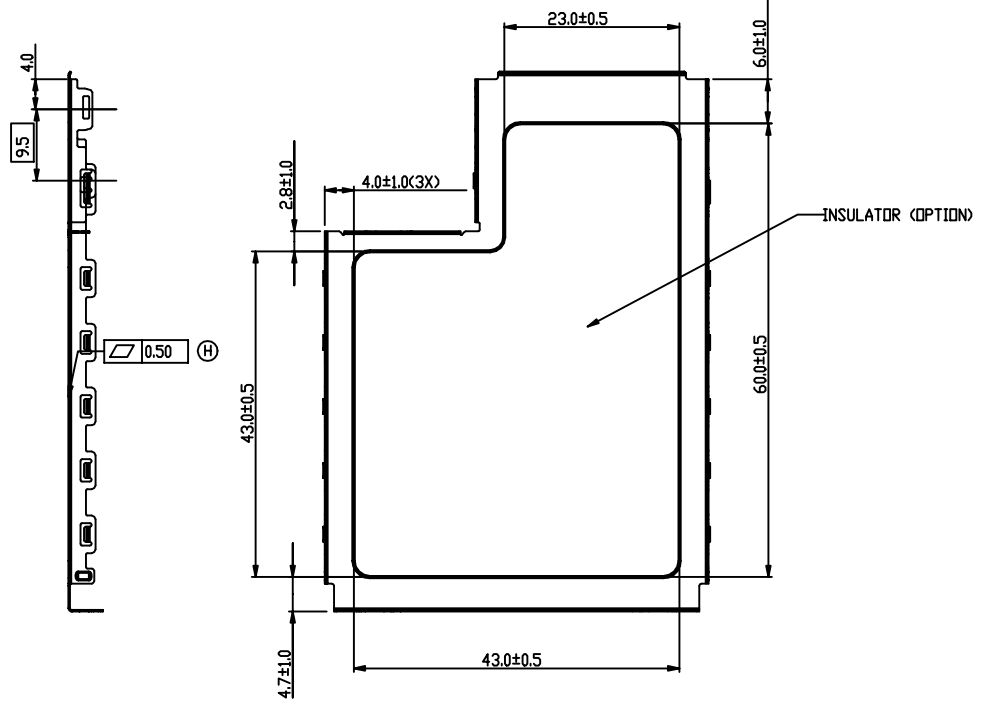
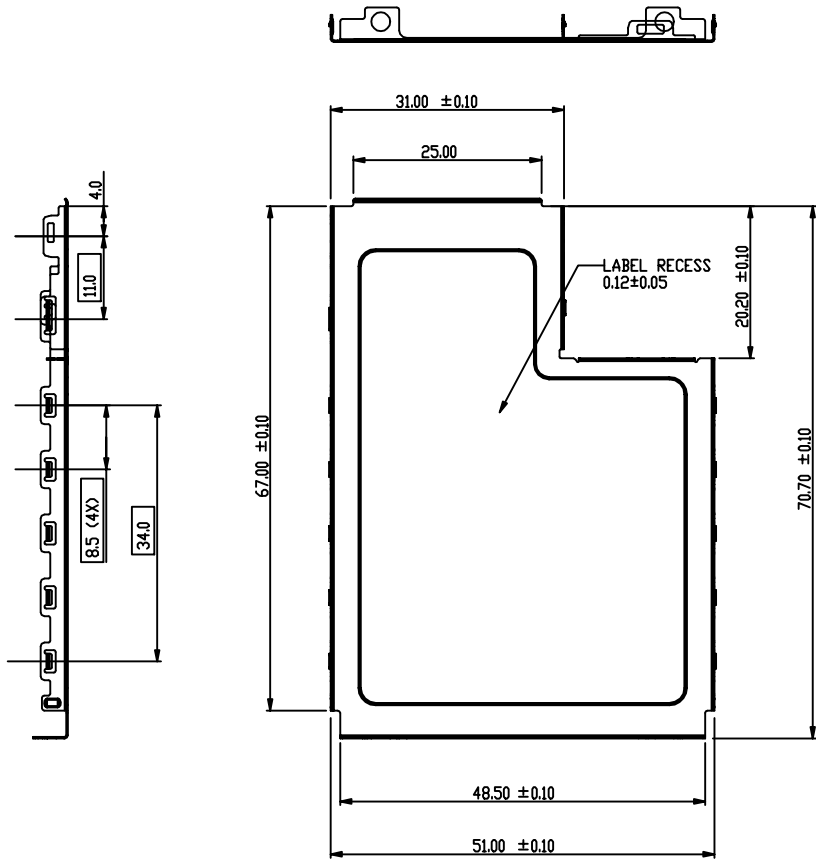

TOLERANCES UNLESS OTHERWISE SPECIFIED		
LINEAR	0.X	±0.30
	0.XX	±0.15
	0.XXX	±0.08
ANGULAR	0°	±2°



title TOP SHIELD SUB-ASSEMBLY  
EXPRESSCARD/54 MODULE CARD KIT  
catalog no 10030581

dwg no 10030581  
CUSTOMER  
sheet 5 of 5  
Rev. H



Copyright FCI.